

20.21.1801.00

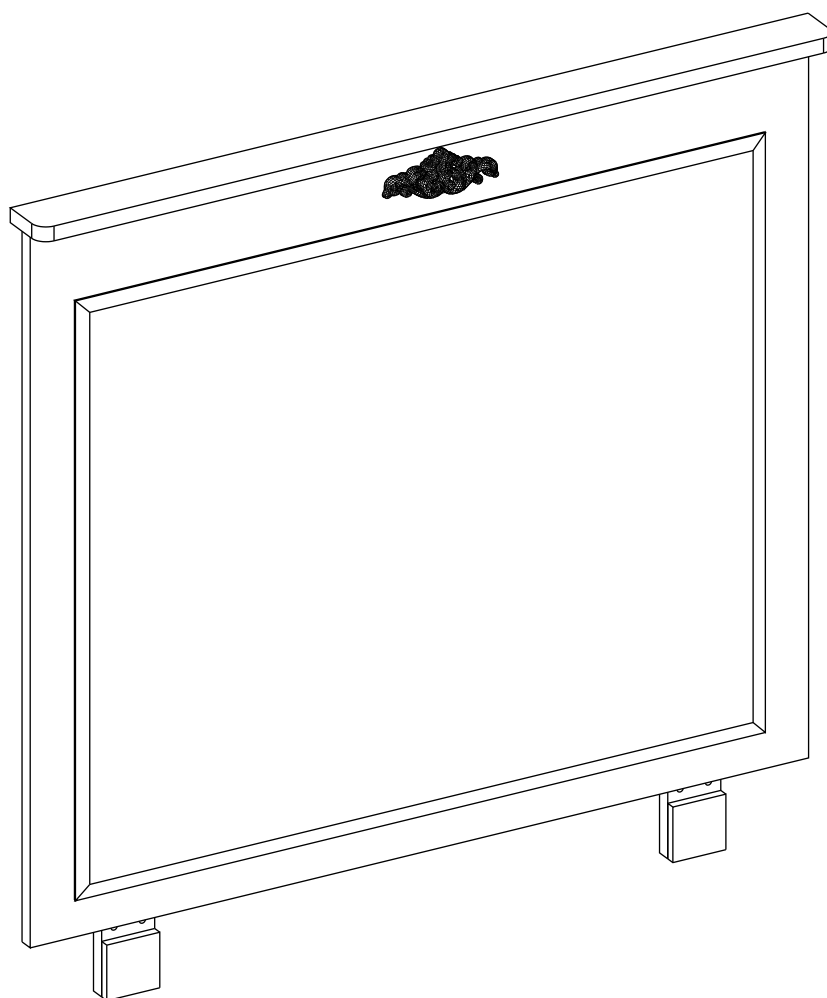

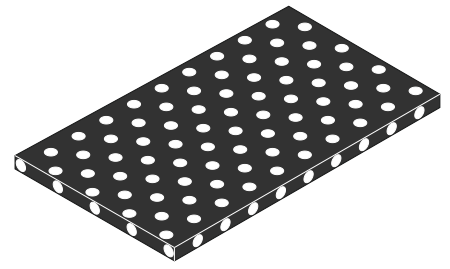

1 / 1

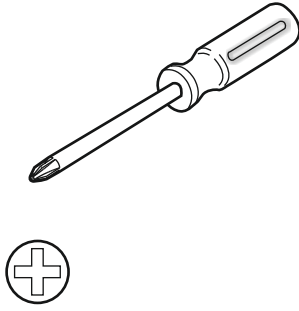
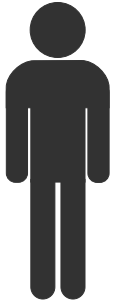
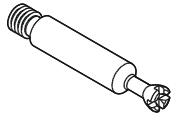

13.07.01.108 x 4



13.07.01.110 x 4



13.01.01.045 x 4

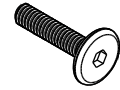

13.03.01.027 x 4

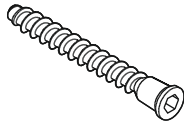

13.02.01.019 x 4

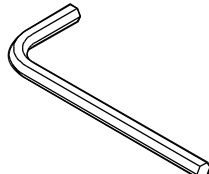

13.07.01.016 x 1

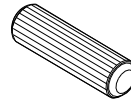

13.01.01.111 x 3

1 / 1

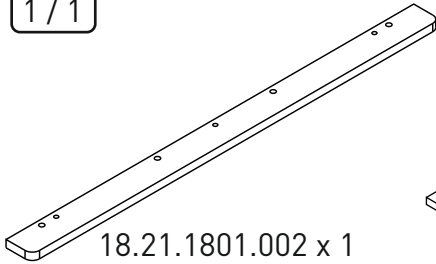

18.21.1801.002 x 1

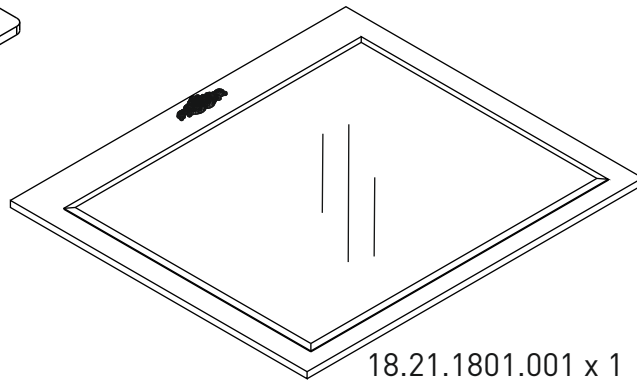

18.21.1801.001 x 1

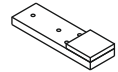

13.14.03.150 x 2

1

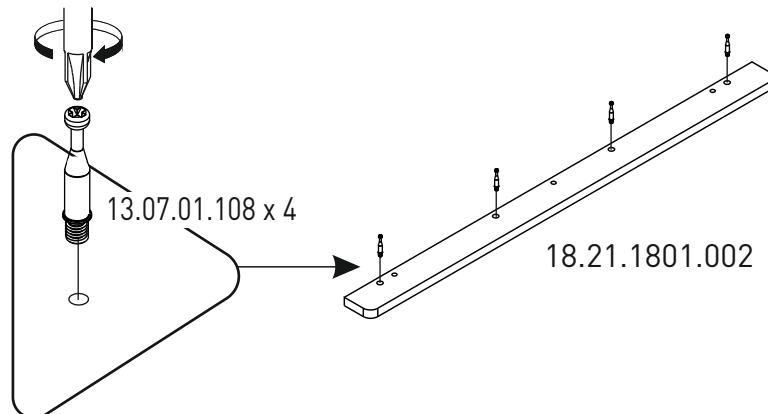

2

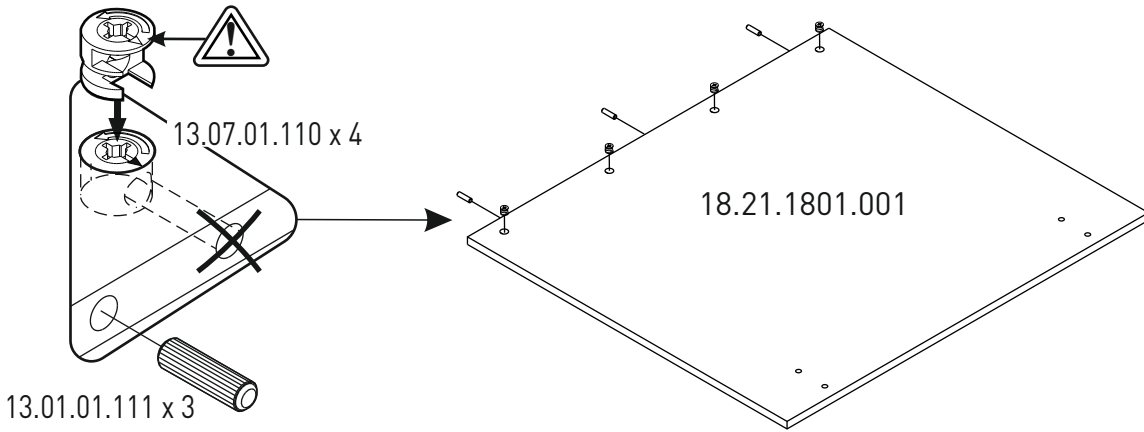

3

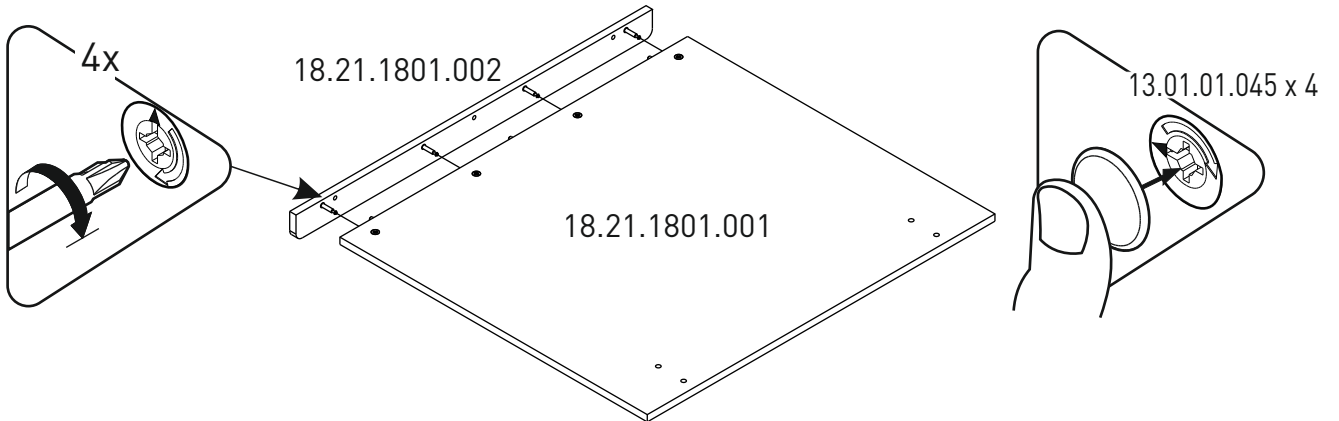

4

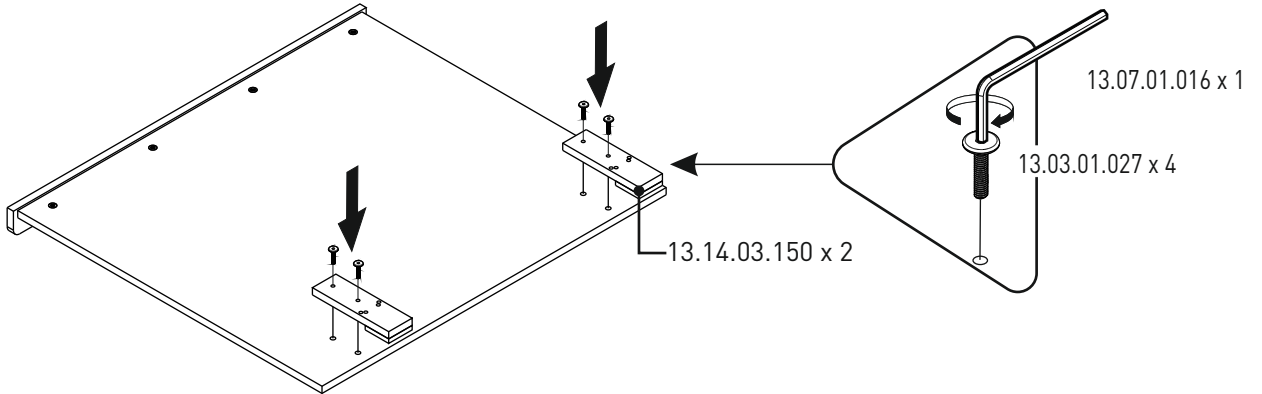

5

