

# by M M M

m o e b e l

90x200cm

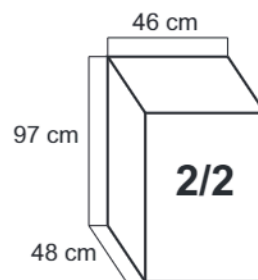
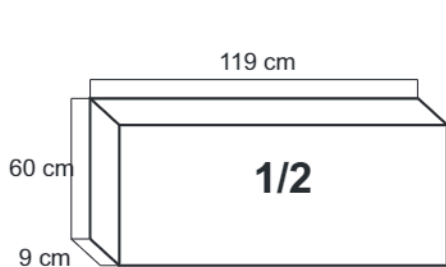
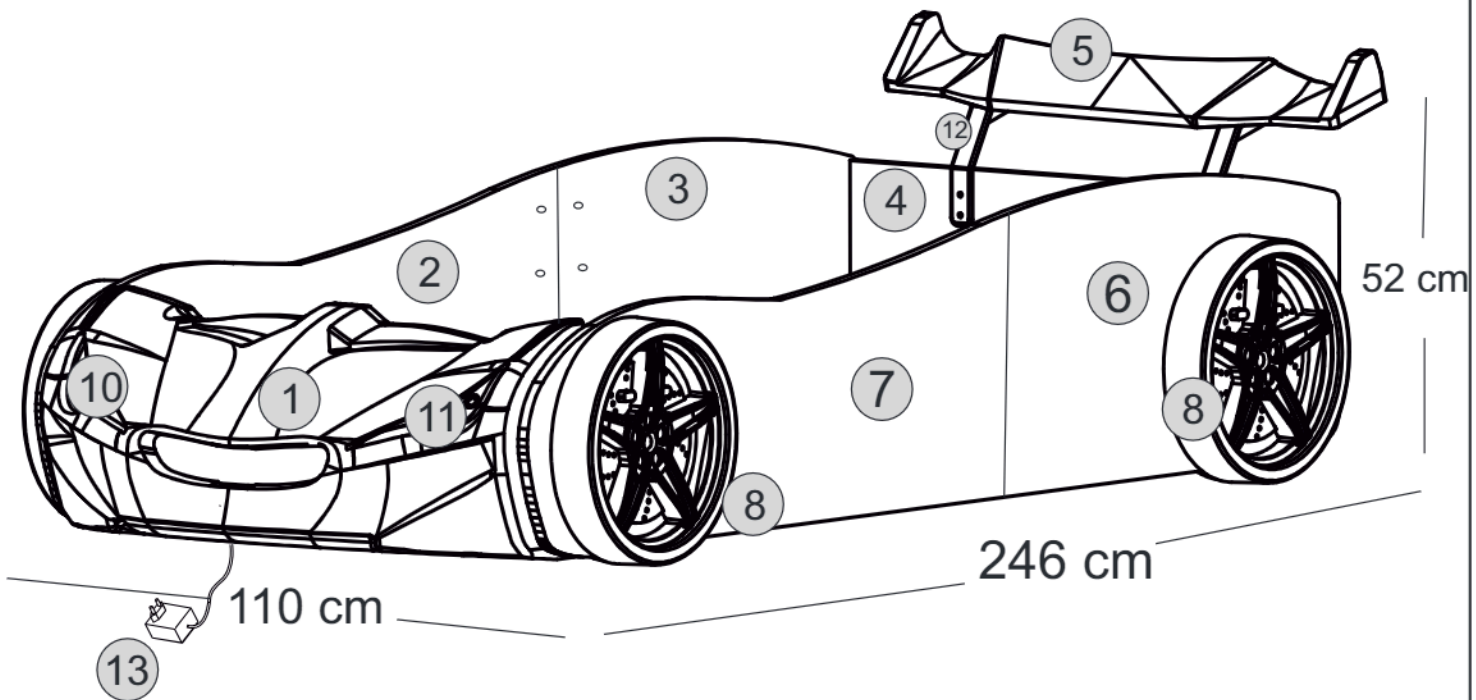

**PRODUCT NAME** TURBO GT1 ECO CAR BED









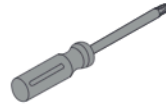
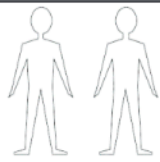



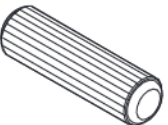

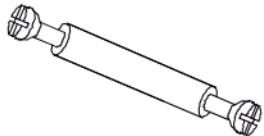
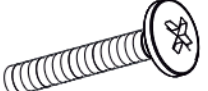
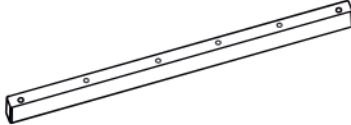
**MODEL NUMBER** SLAT SYSTEM

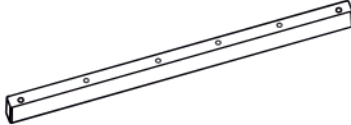

**ASSEMBLY INSTRUCTIONS**

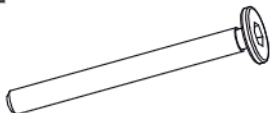
PAGE 1/6

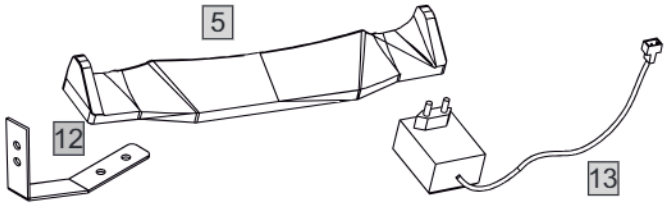

<b>A</b> 	<b>B</b> 	<b>C</b> 	<b>D</b> 
SCHNECKENMUTTER / MINIFIX x16	SCHNECKENSCHRAUBEN MINIFIX STUD x4	SCHNECKENABDECKUNG MINIFIX CAP WHITE x16.	PLASTIC DÜBEL / DOWEL x8
<b>E</b> 	<b>F</b> 	<b>G</b> 	<b>H</b> 
HOLZSCHRAUBEN YHB SCREWS M5x45 x60	FLAT WASHER X60	SCHECKENSCHRAUBEN MINIFIX BILATERAL NEEDLE x6	GEWINDESCHRAUBEN YSB SCREWS M6x35 x6.
<b>14</b> 	<b>R</b> 	<b>14</b> 	<b>L</b> 
<b>15</b> 	<b>R</b> HOLZSCHRAUBEN YHB SCREWS M3x30 x26	<b>R</b> ROSTHALTERUNG SLAT'S SUPPORT x4	<b>L</b> HOLZSCHRAUBEN YSB SCREWS M3x35 x8
<b>15</b> ROST - FEDERLEISTEN SLATS 10	<b>K</b> 	<b>M</b> 	<b>N</b> 
<b>15</b> ROST - FEDERLEISTEN SLATS 10	<b>K</b> GEWINDESCHRAUBEN YSB SCREW M6X12 x4	<b>M</b> IMBUSSCHRAUEBEN FLAT HEAD SCREW M6x60 x4	<b>N</b> HUTMUTTERN DOME NUT M6 x4
<b>O</b> 	<b>P</b> 		
<b>O</b> HOLZSHRAUBEN BACKREST SCREW M3X18 x6	<b>P</b> GEWINDESCHRAUBEN YSB SCREW M6X12 x4	1x SPOILER 2x SPOILER HALTERUNG / SPOILER HOLDER 1x ADAPTER MIT KABEL 3M / ADOPTOR	

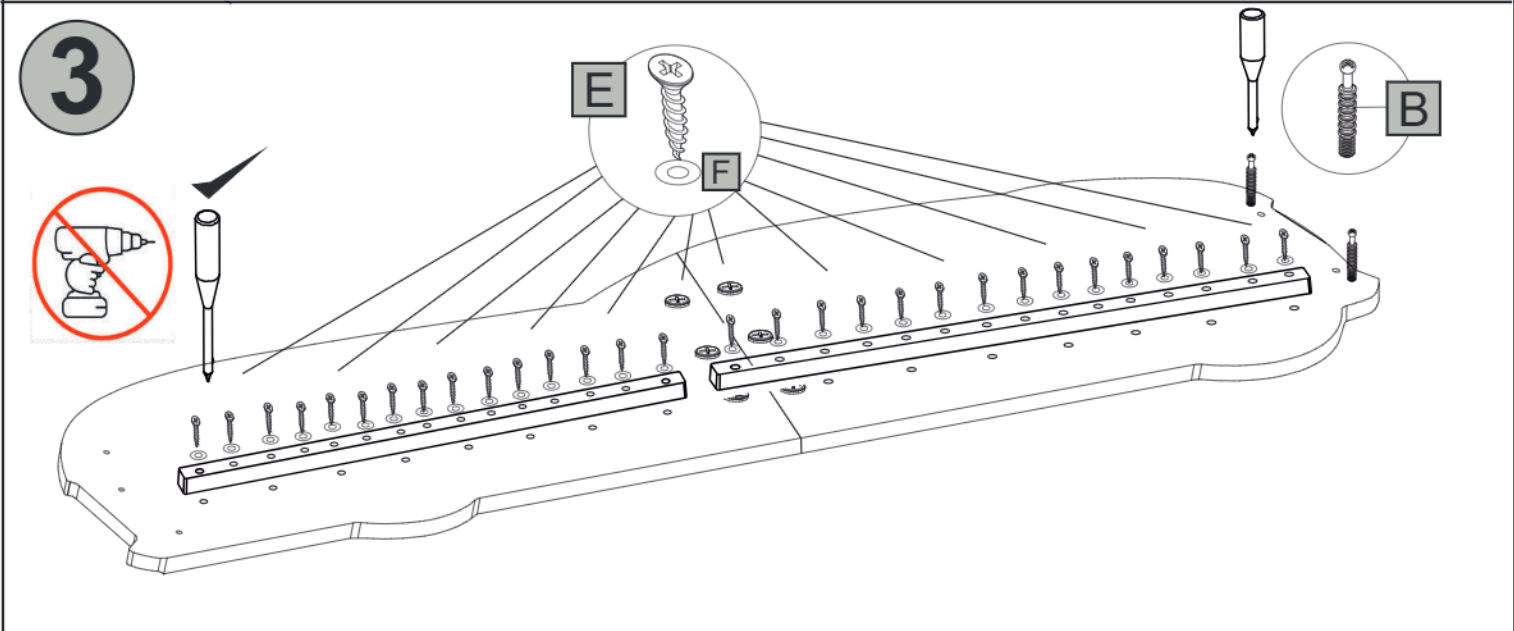
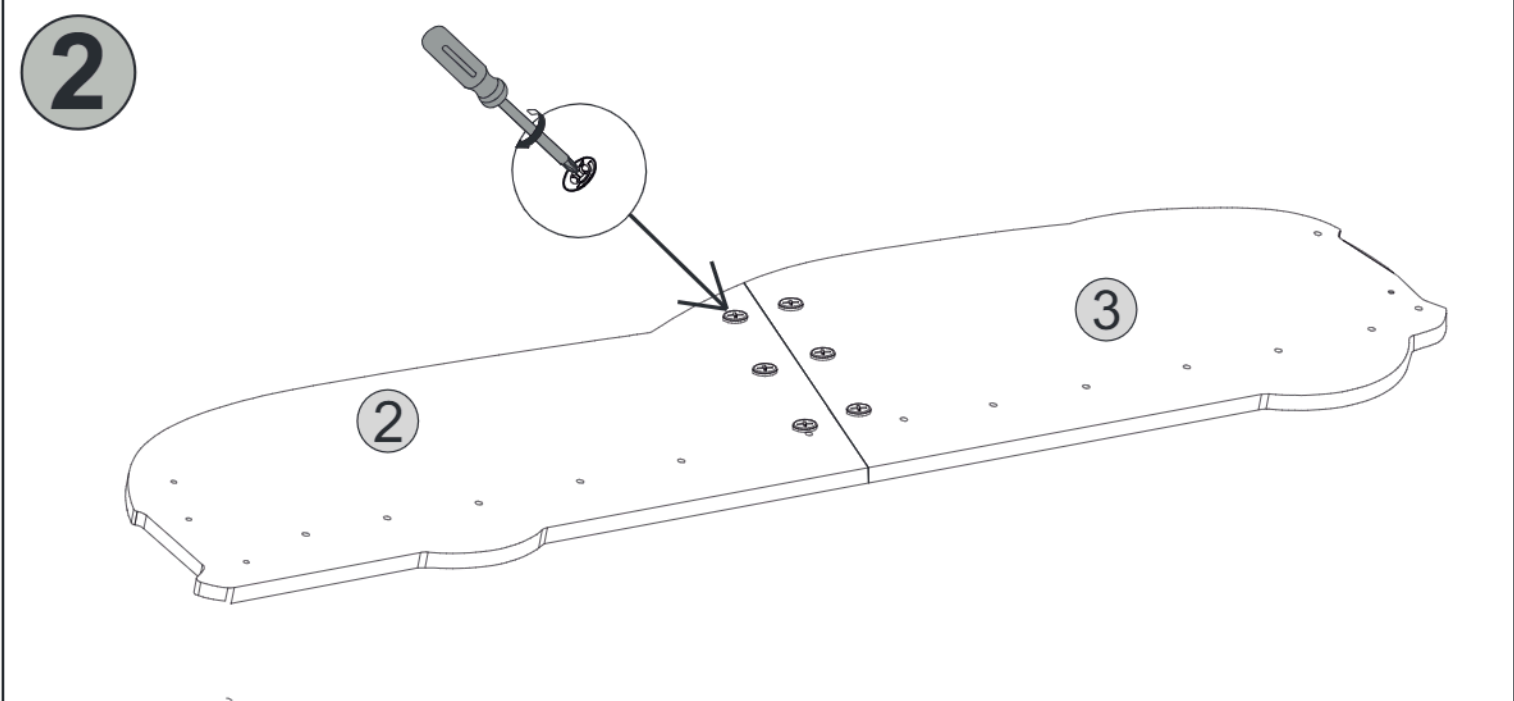
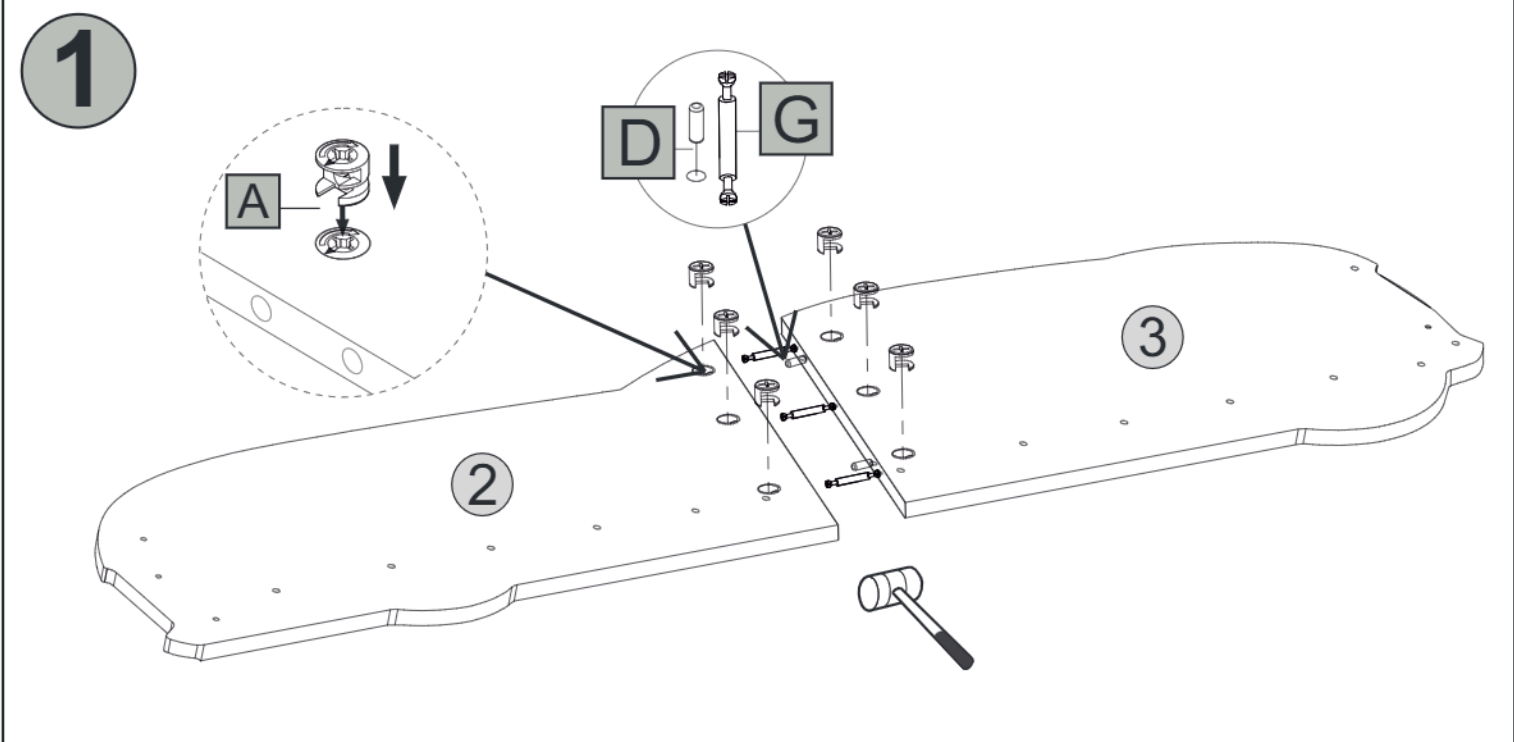

4

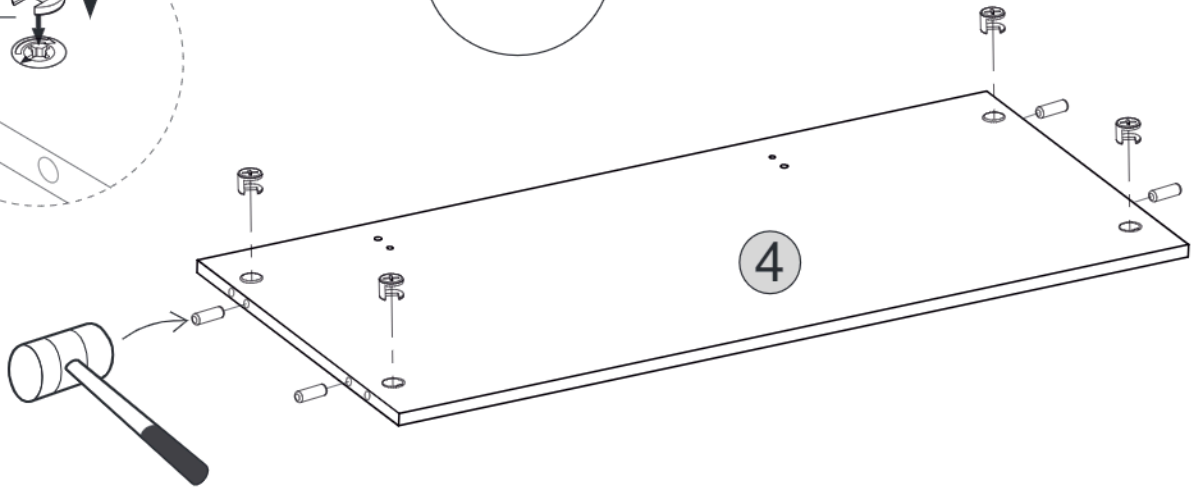
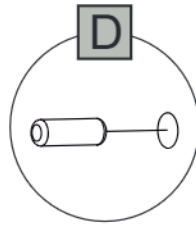
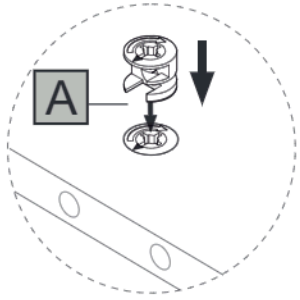

5

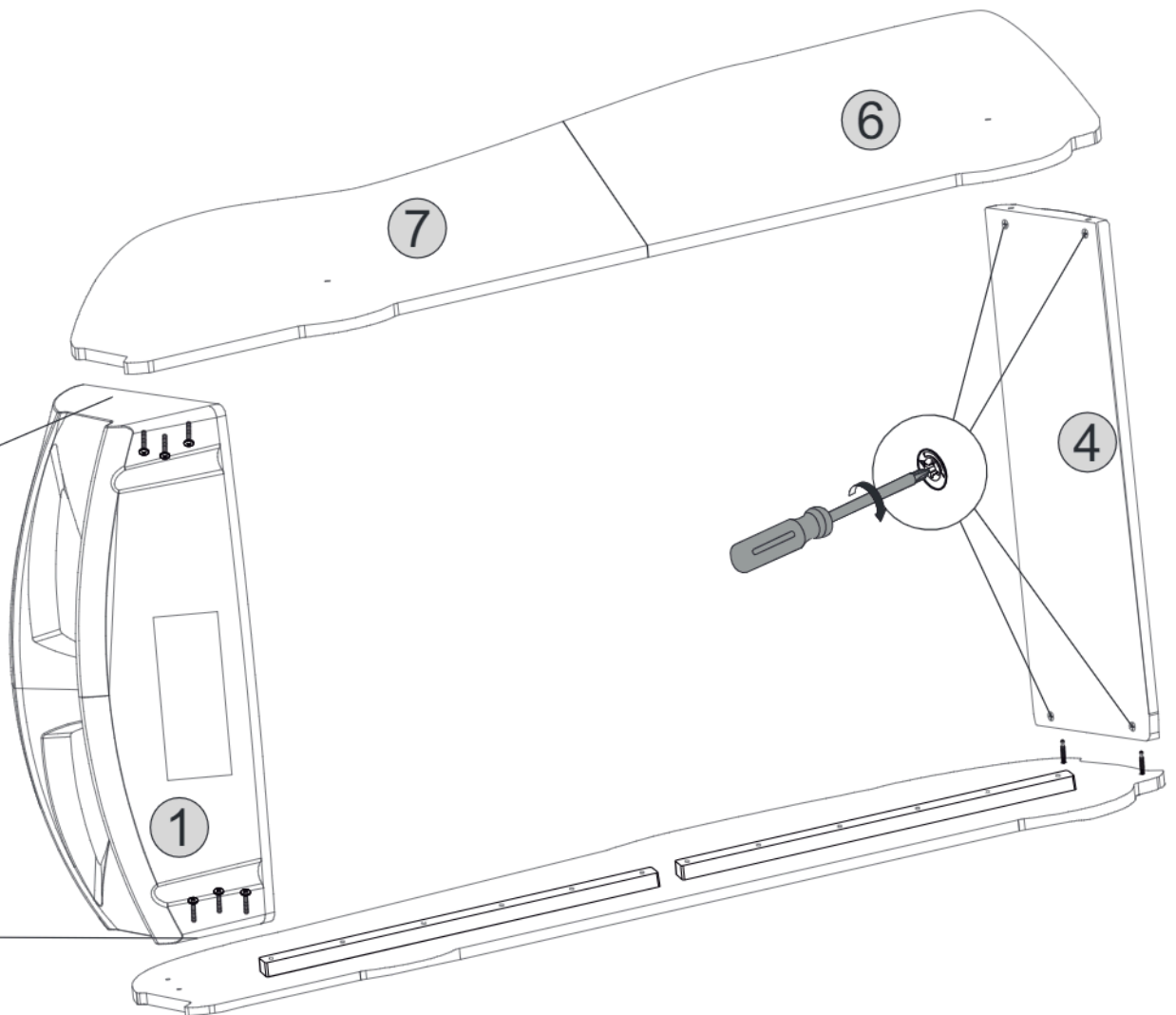
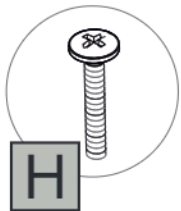

6

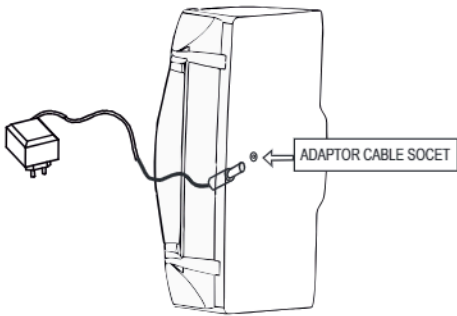
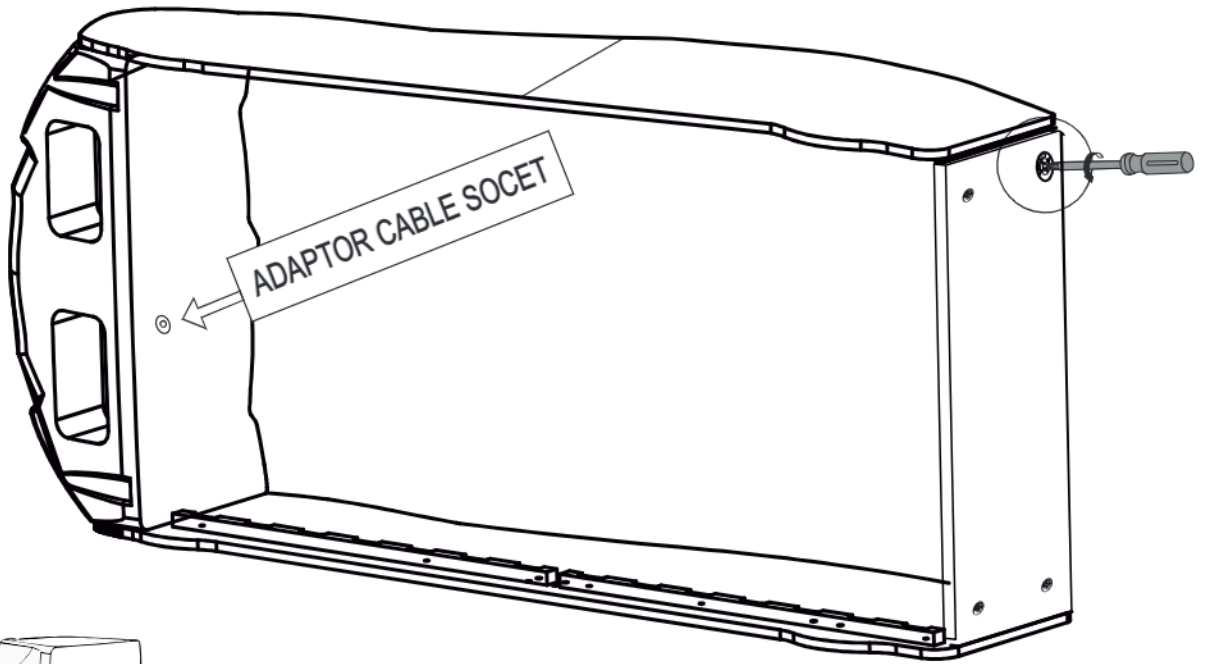

7

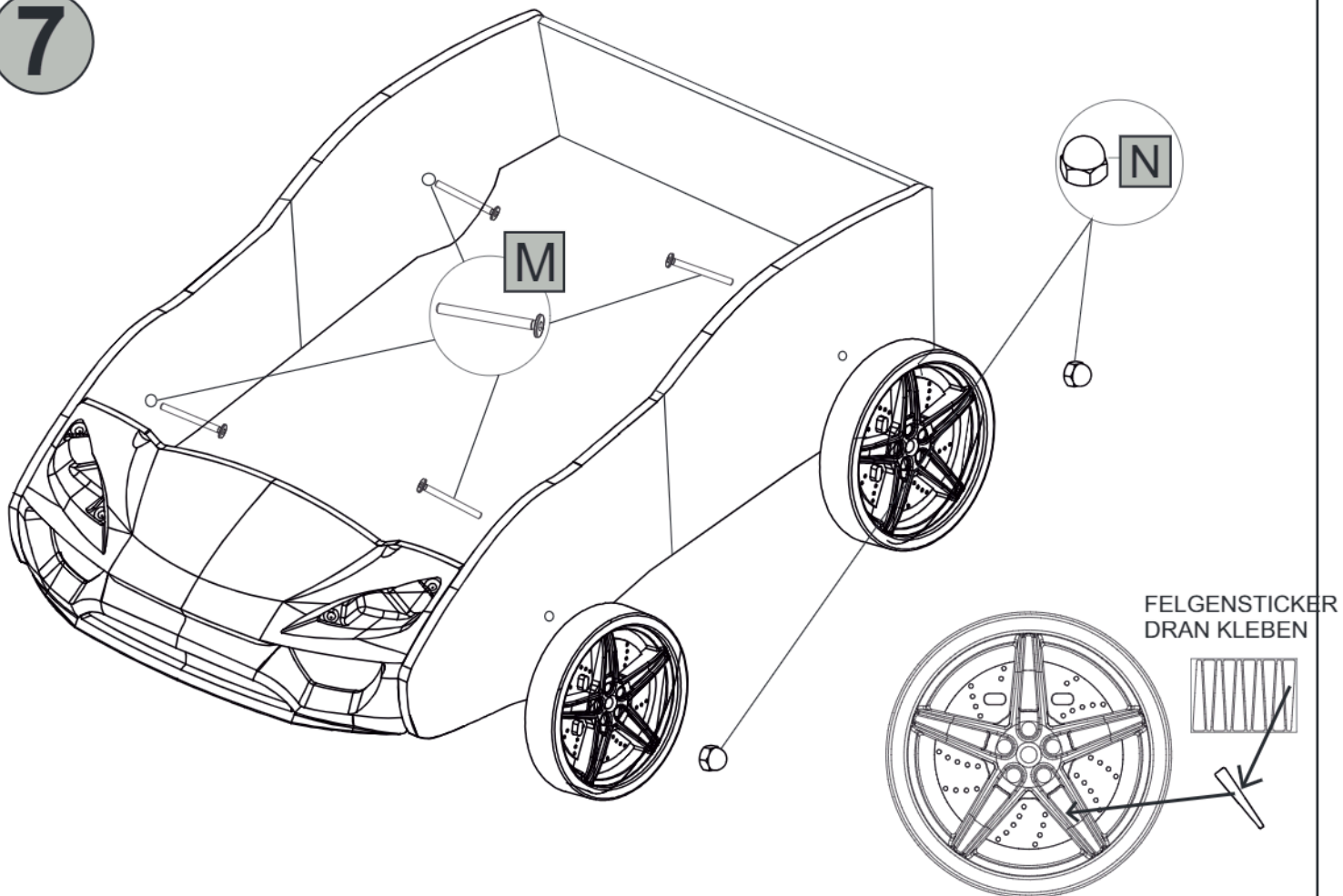

8

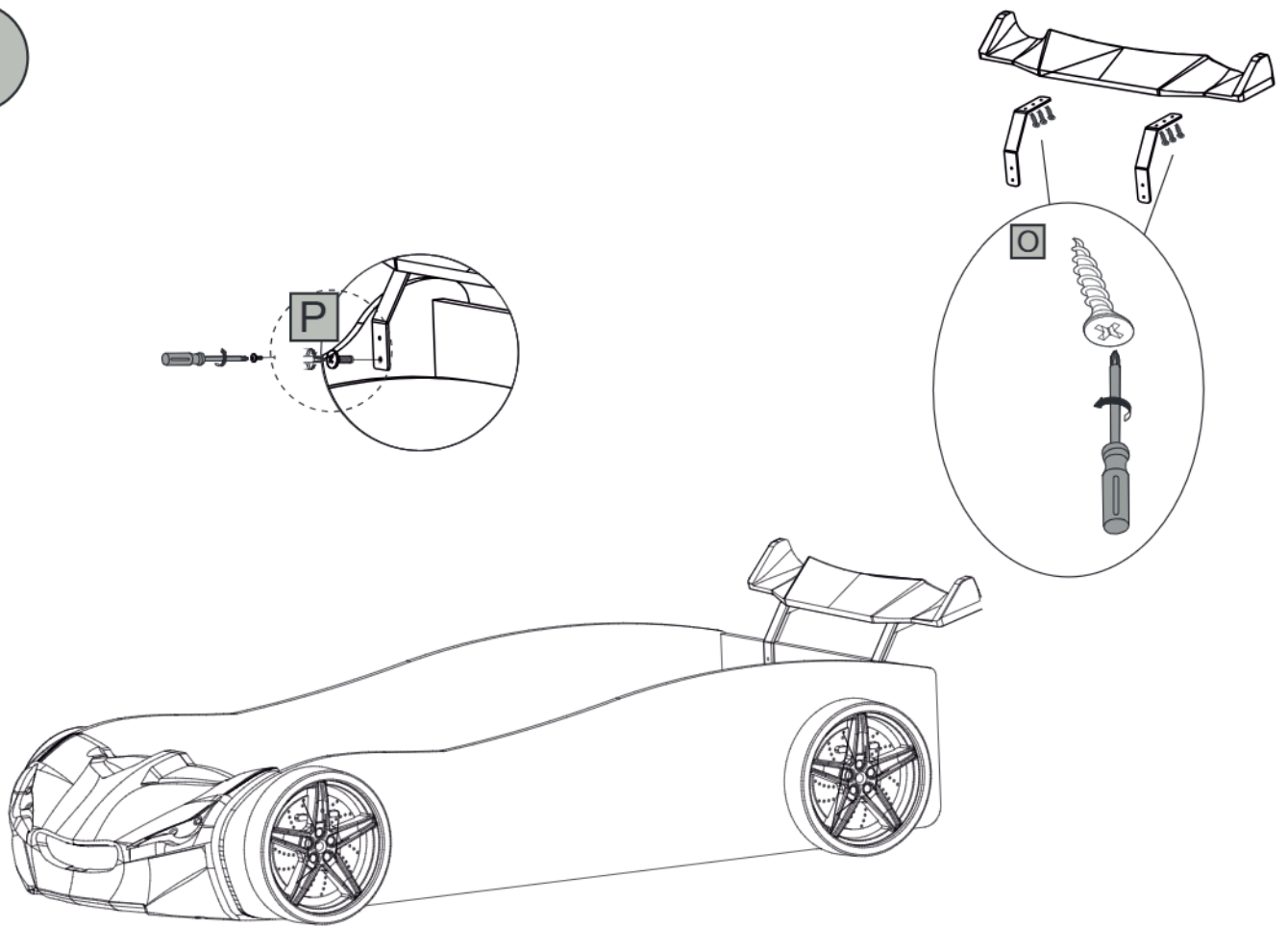

9

